

Varenummer: 0102219
 Beskrivelse: Seeger låsering J 410 DIN 472
 Fjederstål

Mål

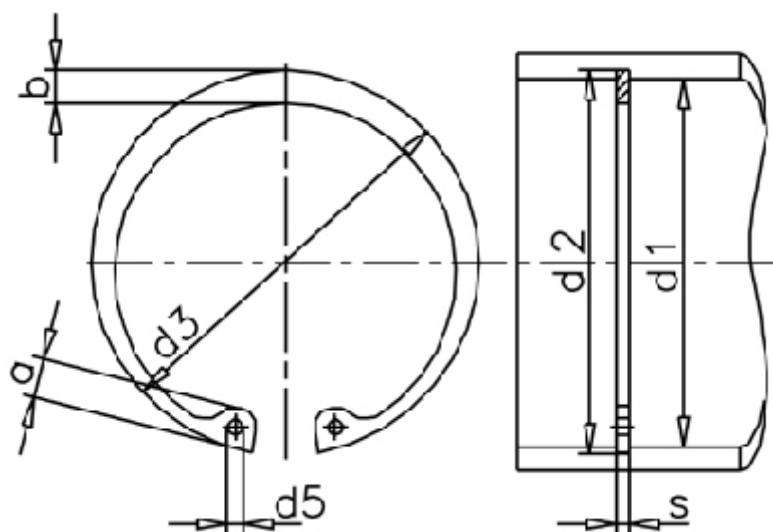

a max	= -	FN kN	= 1307.00	t	= 6.00
AN mm ²	= 7842.0	FRg kN	= 150.0	Tang	= ZGJ-5
b	= 26.0	FR kN	= 1512.0	tol	= -0.15
Betegnelse	= J 410	g	= 6.0	tol	= +2,00-1,00
d1	= 410	K kN-mm	= 3463.0	tol	= +1,00
d2	= 422.0	m min	= 7.20	vægt kg/1000	= 1380.00
d3	= 430.00	Nominel træk	= 18.0		
d5 min	= 6.0	s	= 7.00		